

RALLY MIG 161i

RESERVEDELSLISTE
SPARE PARTS LIST
ERSATZTEILLISTE
LISTE DES PIÈCES DE RECHANGE



MICATRONIC
WELDING VALUE

50115020 A3 Valid from 2019 week 05



RALLYMIG 161i

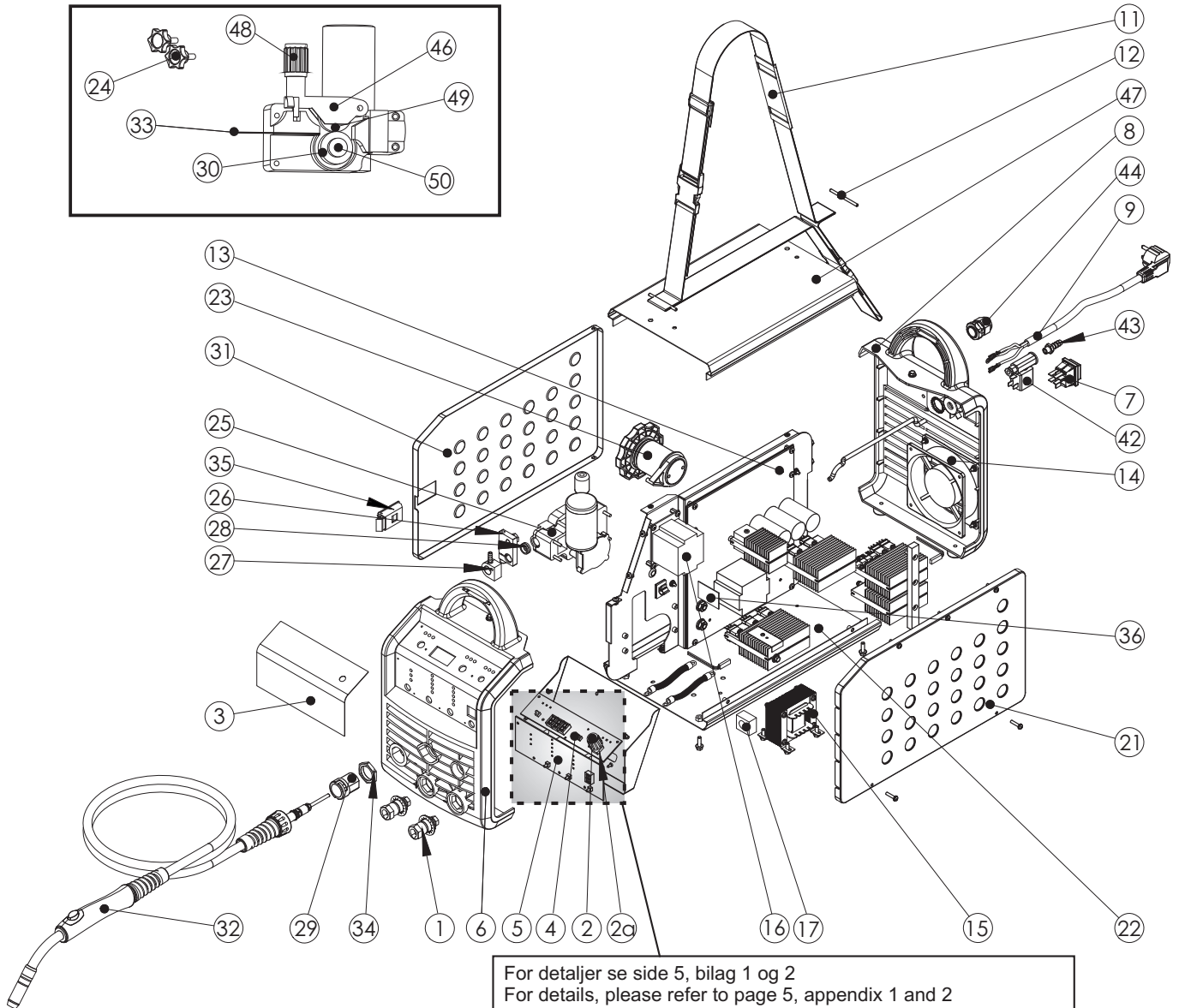

For detaljer se side 5, bilag 1 og 2
 For details, please refer to page 5, appendix 1 and 2
 Einzelheiten entnehmen Sie bitte dem Anhang 1 und 2 auf Seite 5

Pos.	No.	Varebetegnelse Warenbezeichnung	Description of goods Désignation des pièces
1	82046200	Dinsebøsning Dinsebuchse	Dinse coupling socket Douille de raccordement, type Dinse
2	82046201	Knap og Dæksel for knap Knopf und Deckel für den Knopf	Button and cover for button Bouton et couvercle de bouton
2a	17120032	Encoder, 11mm Encoder, 11mm	Encoder, 11mm Encodeur, 11mm
3	82046202	Folie Folie	Foil Feuille
4.1	71613904	Display print, MK2 (gældende fra serienr. 1307xxxx) Display Platine, MK2 (gültig ab Seriennr. 1307xxxx)	Display PCB, MK2 (valid from serial no. 1307xxxx) Carte de circuit imprimé de display, MK2 (valable à partir du numéro de série 1307xxxx)
4.2	71613901	Display print, MK1 (gældende fra serienr. 1208xxxx til 1306xxxx) Display Platine, MK1 (gültig ab Seriennr. 1208xxxx bis 1306xxxx)	Display PCB, MK1 (valid from serial no. 1208xxxx to 1306xxxx) Carte de circuit imprimé de display, MK1 (valable à partir du numéro de série 1208xxxx à 1306xxxx)
5.1	71613903	CPU print, MK2 (gældende fra serienr. 1307xxxx) CPU Platine, MK2 (gültig ab Seriennr. 1307xxxx)	CPU control PCB, MK2 (valid from serial no. 1307xxxx) Carte de circuit imprimé de CPU, MK2 (valable à partir du numéro de série 1307xxxx)
5.2	71613902	CPU print, MK1 (gældende fra serienr. 1208xxxx til 1306xxxx) CPU Platine, MK1 (gültig ab Seriennr. 1208xxxx bis 1306xxxx)	CPU control PCB, MK1 (valid from serial no. 1208xxxx to 1306xxxx) Carte de circuit imprimé de CPU, MK1 (valable à partir du numéro de série 1208xxxx à 1306xxxx)







RALLYMIG 161i

Pos. No.	Varebetegnelse Warenbezeichnung	Description of goods Désignation des pièces
6	82046203 Plastikfront	Plastic front
	Plastikfront	Façade plastique
7	82046204 Afbryder, vandtæt	Switch, waterproof
	Schalter, wasserdicht	Interrupteur, étanche à l'eau
8	82046205 Plastikbag	Plastic back
	<i>(Husk også at bestille kabelafledning 82046244 pos. 44)</i>	<i>(Moreover, please remember to order cable relief 82046244 pos. 44)</i>
	Plastickrückwand	Façade postérieure plastique
	<i>(Bitte bestellen Sie auch Kabeldurchführung 82046244 pos. 44)</i>	<i>(N'oubliez pas de commander le traverser de câble 82046244 du n° 44)</i>
9	82046206 Netkabel med schuko stik	Mains supply cable with schuko plug
	Netzkabel mit Schuko Stecker	Câble d'alimentation avec prise schuko
11	82046208 Bærerem	Carrying strap
	Tragriemen	Carrying strap
12	82046209 Remstrammer	Carrying strap fastener
	Riemenspanner	Fixation pour sangle de transport
13.1	82046250 Invertermodul, MK2 <i>(gældende fra serienr. 1307xxxx)</i>	Inverter module, MK2 <i>(valid from serial no. 1307xxxx)</i>
	Invertermodul, MK2 <i>(gültig ab Serienr. 1307xxxx)</i>	Module onduleur, MK2 <i>(valable à partir du numéro de série 1307xxxx)</i>
13.2	82046210 Invertermodul, MK1 <i>(gældende fra serienr. 1208xxxx til 1306xxxx)</i>	Inverter module, MK1 <i>(valid from serial no. 1208xxxx to 1306xxxx)</i>
	Invertermodul, MK1 <i>(gültig ab Serienr. 1208xxxx bis 1306xxxx)</i>	Module onduleur, MK1 <i>(valable à partir du numéro de série 1208xxxx à 1306xxxx)</i>
14	82046211 Ventilator med ledningssæt	Fan with wire set
	Lüfter mit Leitungssatz	Ventilateur avec jeu de câble
15	82046212 Drossel	Choke
	Drossel	Inducteur
16.1	82046253 PFC spole m/skrueterminaler, MK2 <i>(gældende fra serienr. 1307xxxx)</i>	PFC choke with screw terminals, MK2 <i>(valid from serial no 1307xxxx)</i>
	PFC drossel, MK2 <i>(gültig ab Serienr. 1307xxxx)</i>	PFC inducteur, MK2 <i>(valable à partir du numéro de série 1307xxxx)</i>
16.2	82046213 PFC spole, MK1 <i>(gældende fra serienr. 1208xxxx til 1306xxxx)</i>	PFC choke, MK1 <i>(valid from serial no 1208xxxx to 1306xxxx)</i>
	PFC drossel, MK1 <i>(gültig ab Serienr. 1208xxxx bis 1306xxxx)</i>	PFC inducteur, MK1 <i>(valable à partir du numéro de série 1208xxxx à 1306xxxx)</i>
17	82046214 Strømsensor	Current sensor
	Stromsensor	Decteur de courant
21	82046218 Sideskærm, højre	Side panel, right
	Seitenschirm, rechts	Plaque latérale droit
22	82046219 Bund	Bottom
	Boden	Plaque de base
23.1	82046251 Bremsenav med lås, MK2 <i>(gældende fra serienr. 1307xxxx)</i>	Brake hub with lock, MK2 <i>(valid from serial no. 1307xxxx)</i>
	Bremsenabe mit Verschluss, MK2 <i>(gültig ab Serienr. 1307xxxx)</i>	Moyeu de frein avec fermoir, MK2 <i>(valable à partir du numéro de série 1307xxxx)</i>
23.2	82046221 Bremsenav m/lås, MK1 <i>(gældende fra serienr. 1208xxxx til 1306xxxx)</i>	Brake hub with lock, MK1 <i>(valid from serial no 1208xxxx to 1306xxxx)</i>
	Bremsenabe m/Verschluss, MK1 <i>(gültig ab Serienr. 1208xxxx bis 1306xxxx)</i>	Moyeu de frein avec fermoir, MK1 <i>(valable à partir du numéro de série 1208xxxx à 1306xxxx)</i>
24	82046222 Fingerskrue f. polvendning	Milled knob f. reverse of polarity
	Rändelschraube f. Umpolung	Vis moleté pour inverser la polarité
25	82046223 Trådfremføring komplet	Wire feed unit complete
	Drahtvorschubeinheit Komplet	Dispositif de guidage de fil
26	82046224 Strømskinne	Power rail
	Stromschiene	Plaque cuivre
27	82046225 Gastilslutning	Gas connection
	Gasanschluss	Raccordement au gaz
28	82046226 Styrring for svejseslange	Support ring for welding torch
	Stützring für Schweißschlauch	Bague support pour tuyau de soudage
29	82046228 Kabelgennemføring	Cable lead-in
	Kabeldurchführung	Traversée de câble
30.1	82046229 Trisse 0,6 V-Spor - 0,8 V-Spor	Wire drive roll 0.6 V-Groove - 0.8 V-Groove
	Drahtrolle 0,6 V-Spuhr - 0,8 V-Spuhr	Galet 0,6 V-trace - 0,8 V-trace
30.2	82046230 Trisse 0,8 V-Spor - 1,0 V-Spor	Wire drive roll 0.8 V-Groove - 1.0 V-Groove
	Drahtrolle 0,8 V-Spuhr - 1,0 V-Spuhr	Galet 0,8 V-trace - 1,0 V-trace
30.3	82046232 Trisse 0,8 U-Spor - 1,0 U-Spor	Wire drive roll 0.8 U-Groove - 1.0 U-Groove
	Drahtrolle 0,8 U-Spuhr - 1,0 U-Spuhr	Galet 0,8 U-trace - 1,0 U-trace
31	82046231 Låge	Door
	Tür	Portillon
32.1	80191180 ML 161 svejseslange	ML 161 hose
	ML 161 Schweißschlauch	ML 161 tuyau de soudage
32.2	80392615 TIG Ergo 101V svejseslange	TIG Ergo 101V hose
	TIG Ergo 101V Schweißschlauch	TIG Ergo 101V tuyau de soudage
33	80160152 Liner indløb (ALU-svejsning)	Wire guide inlet (ALU-welding)
	Drahtführungsspirale (ALU-Schweißen)	Guide fil (soudage ALU)
34	82046227 Møtrik, M27	Nut, M27
	Mutter, M27	Ecrou, M27
35	82046233 Lås for låge	Latch for door
	Verschluss für Tür	Fermeoir, portillon
36	82046236 PWM print	PWM PCB
	PWM Platine	Circuit imprimé PWM

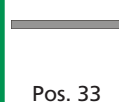

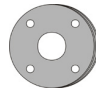
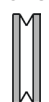
RALLYMIG 161i

Pos. No.	Varebetegnelse Warenbezeichnung	Description of goods Désignation des pièces
37	82046234 Fladkabel 26pol Flachkabel 26 polig	Flat cable 26-pole Câble méplat, 26-pôles
38	82046235 Fladkabel 34pol Flachkabel 34 polig	Flat cable 34-pole Câble méplat, 34-pôles
39	82046237 SD-kortlæser (gældende fra serienr. 1208xxxx til 1306xxxx) SD-Kartenleser (gültig ab Seriennr. 1208xxxx bis 1306xxxx)	SD card reader (valid from serial no. 1208xxxx to 1306xxxx) Lecteur carte SD (Valable à partir du numéro de série 1208xxxx à 1306xxxx)
40	82046240 Fladkabel 10pol (gældende fra serienr. 1208xxxx til 1306xxxx) Flachkabel 10 polig (gültig ab Seriennr. 1208xxxx bis 1306xxxx)	Flat cable 10-pole (valid from serial no. 1208xxxx to 1306xxxx) Câble méplat, 10-pôles (Valable à partir du numéro de série 1208xxxx à 1306xxxx)
41	78861297 Servicekit - SW opgradering Servicekit - Softwareaufgradieren	Servicekit - software upgrade Servicekit - mise à jour logicielle
42	82046242 Gasventil	Gas valve Valve de gaz
43	82046243 Gasstuds Gasstutzen	Gas connecting piece Raccord gaz
44	82046244 Kabelaflastning Kabeldurchführung	Cable relief Traverser de câble
46	82046255 Trådrullebom Drahtrollen-Druckarm	Wire coil pressure arm Bras presseur
47	82046245 Topplade Oberplatte	top plate Plaque supérieure
48	82046246 Strammemekanisme til trådfremføringsbom Anziehmechanismus für DrahtführungsVorrichtung	Tightening mechanism for wire feeder boom
49	82046269 Kugleleje med split til trådfremføring Kugellager mit Schlitz für Drahtvorschub	Ball bearing with split for wire feeder
50	82046268 Låseskrue til trisse Verschlusschraube f.Drahtolle	Lock screw for wire roll
81100137	Kit for ALU-svejsning Bausatz für Aluminiumschweißen	Kit for aluminium welding Kit pour soudage d'aluminium

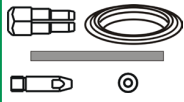
ML 161 i									
Wire	Inlet guide	Wire dia.	Wire roll	Wire roll size	Nipple torch	O-ring	Liner torch	Contact tip	Kit
	 Pos. 33				 Pos. 15	 Pos. 19	 Pos. 9+10	 Pos. 3	
FE	Steel liner 80160153*	0.6 0.8 1.0	82046229 82046230 82046230	0.6-0.8 V 0.8-1.0 V 0.8-1.0 V	80100006 80100815* 80100815*	43571001 43571001 43571001	80160520 80160521* 80160521*	80130201 80130202* 80130203	
ALU/CuSi 3%	Plastic liner 80160152	1.0	82046232	0.8-1.0 U	80100006	43571001	80160560	80130103	81100137
Stainless	80160152	0.8	82046230	0.8-1.0 V	80100006	43571001	80160700	80130202	81100138
FCW Innershield	Steel liner 80160153*	0.9	82046230	0.8-1.0 V	80100815*	43571001	80160521*	80130103	
Pos. = Machine spare parts list					Pos. = Torch spare parts list				

* Standard equipment

RALLYMIG 161i

Valid from serial number 1307xxxx

Bilag 1
Appendix 1
Anhang 1

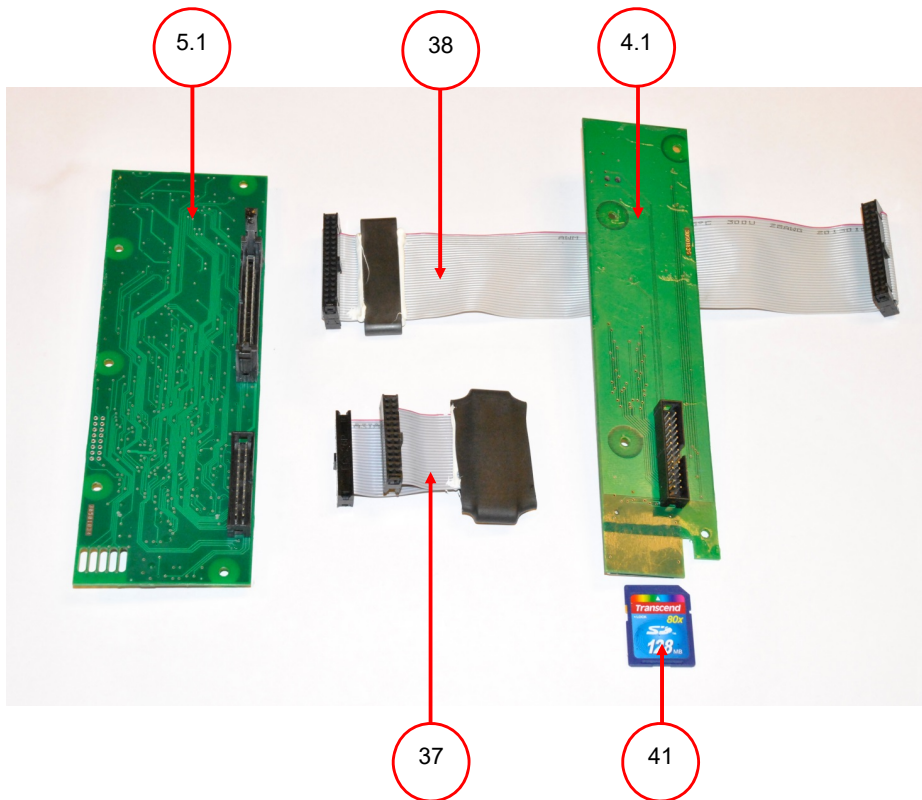

Valid from serial number 1208xxxx to 1306xxxx

Bilag 2
Appendix 2
Anhang 2

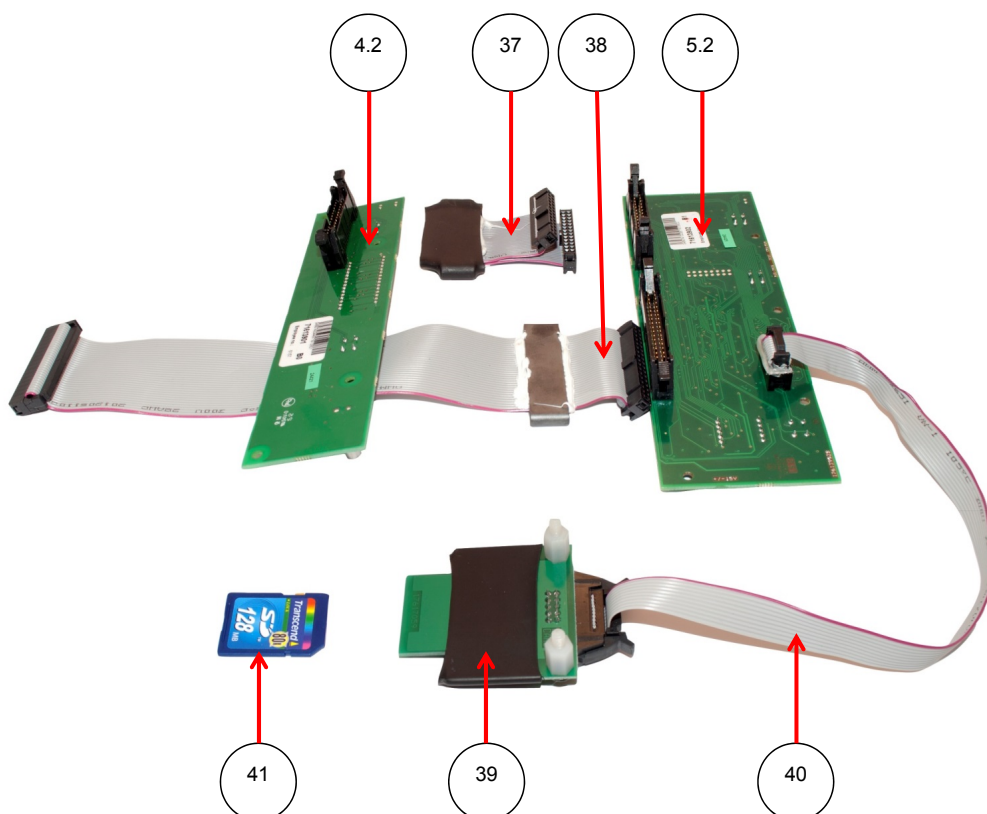



RALLYMIG 161i

Valid from serial number 1307xxxx

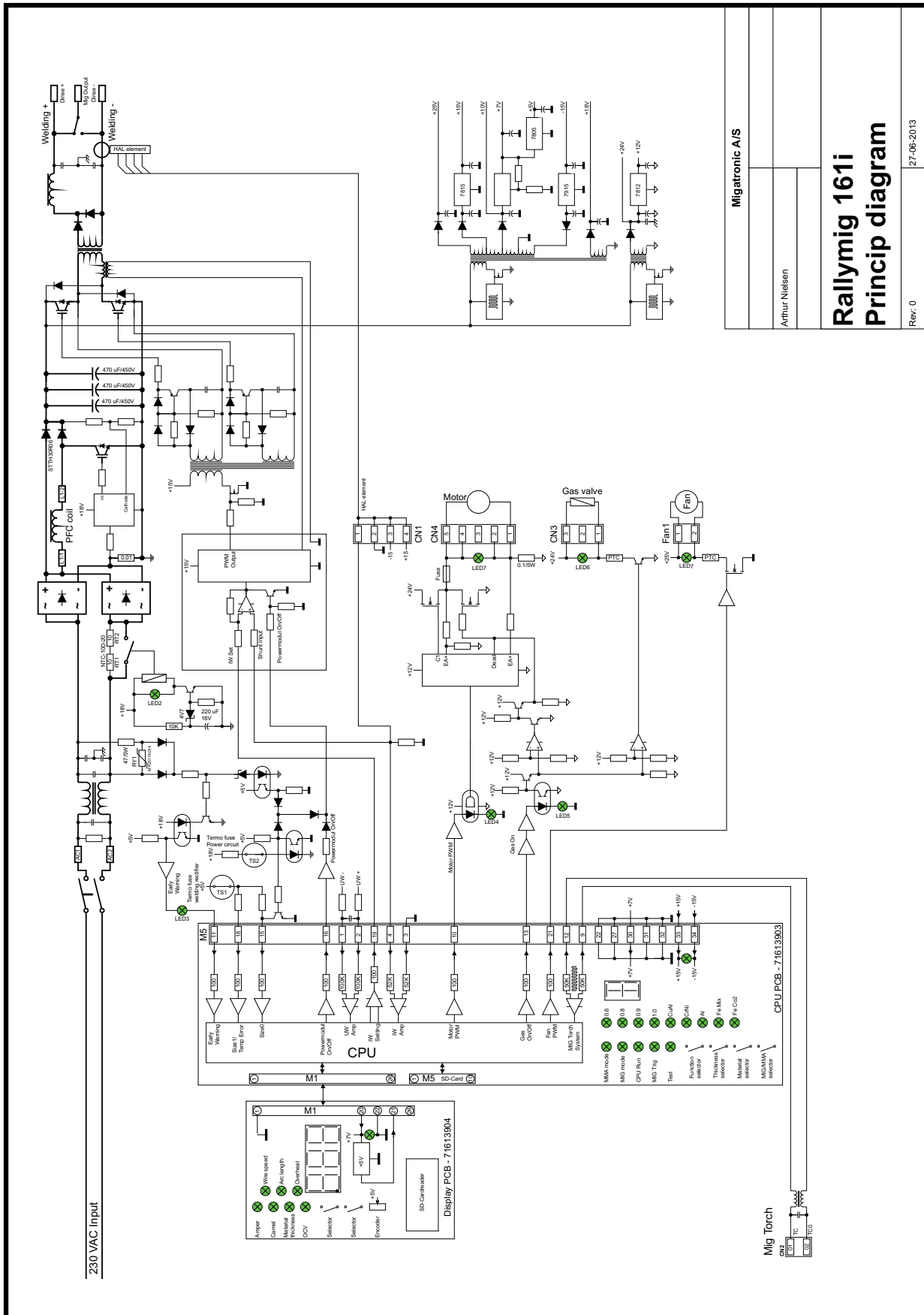

Migatronic A/S
 Arthur Nielsen
Rallymig 161i
Princip diagram
 Rev: 0
 27-06-2013



RALLYMIG 161i

Valid from serial number 1208xxxx to 1306xxxx

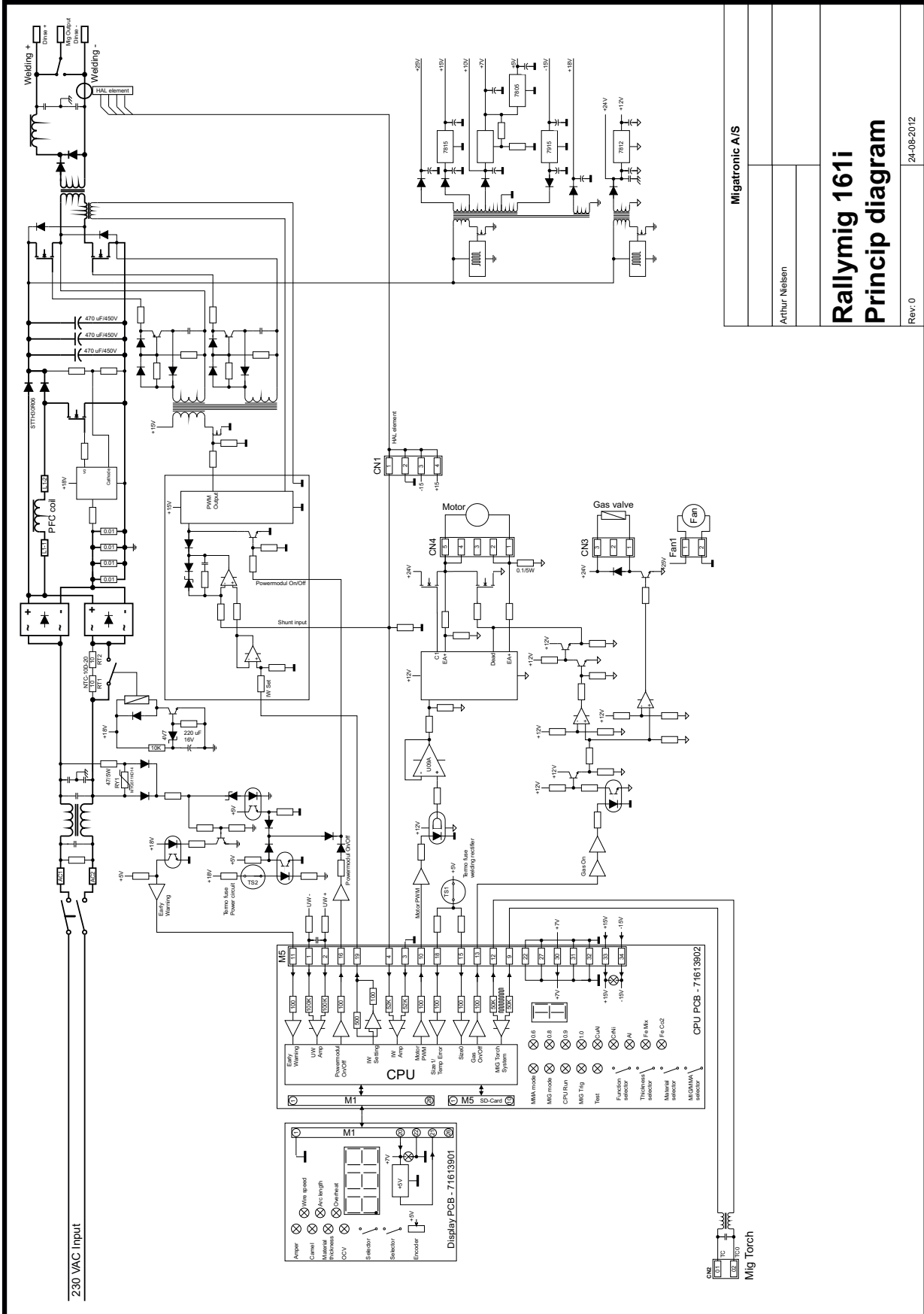

Migatronic A/S

Arthur Nielsen

Rallymig 161i
Princip diagram

Rev: 0 24-08-2012



DENMARK:

Main office

SVEJSEMASKINEFABRIKKEN MIGATRONIC A/S
Aggersundvej 33, DK-9690 Fjerritslev, Denmark
Tel. +45 96 500 600, www.migatronic.com

MIGATRONIC AUTOMATION A/S

Knøsgårdvej 112, DK-9440 Aabybro, Denmark
Tel. +45 96 96 27 00, www.migatronic-automation.dk

MIGATRONIC EUROPE:

Great Britain

MIGATRONIC WELDING EQUIPMENT LTD
21 Jubilee Drive, Belton Park, Loughborough
GB-Leicestershire LE11 5XS, Great Britain
Tel. +44 01509/267499, www.migatronic.co.uk

France

MIGATRONIC EQUIPEMENT DE SOUDURE S.A.R.L.
Parc Avenir II, 313 Rue Marcel Merieux
FR-69530 Brignais, France
Tel. +33 04 78 50 65 11, www.migatronic.fr

Italy

MIGATRONIC s.r.l. IMPIANTI PER SALDATURA
Via Dei Quadri 40, IT-20871 Vimercate (MB), Italy
Tel. +39 039 9278093, www.migatronic.it

Norway

MIGATRONIC NORGE AS
Industriveien 6, N-3300 Hokksund, Norway
Tel. +47 32 25 69 00, www.migatronic.no

Czech Republic

MIGATRONIC CZ a.s.
Tolstého 451, CZ-415 03 Teplice 3, Czech Republic
Tel. +420 411 135 600, www.migatronic.cz

Hungary

MIGATRONIC KERESKEDELMI KFT.
Szent Miklós u. 17/a, H-6000 Kecskemét, Hungary
Tel. +36 76 505 969 www.migatronic.hu

Finland

MIGATRONIC OY
PL 105, FI-04301 Tuusula, Finland
Tel. +358 0102 176 500, www.migatronic.fi

Holland

MIGATRONIC NEDERLAND B.V.
Hallenweg 34, NL-5683 CT Best, Holland
Tel. +31 499 37 50 00, www.migatronic.nl

Sweden

MIGATRONIC SVETSMASKINER AB
Nåäs Fabriker, Box 5015,S-448 50 Tollerød, Sweden
Tel. +46 031 44 00 45, www.migatronic.se

Germany

MIGATRONIC SCHWEISSMASCHINEN GMBH
Sandusweg 12, D-35435 Wetztenberg-Launsbach, Germany
Tel. +49 0641/98284-0, www.migatronic.de

MIGATRONIC ASIA:

China

SUZHOU MIGATRONIC WELDING TECHNOLOGY CO. LTD
#4 FengHe Road, Industrial Park, CH-SuZhou, China
Tel. +86 0512-87179800, www.migatronic.cn

India

MIGATRONIC INDIA PRIVATE LTD.
No.22 & 39/20H Sowri Street,
IN-Alandur, Chennai – 600 016, India
Tel. +91 44 2233 0074 www.migatronic.in



MIGATRONIC
WELDING VALUE